

SERIES TNC REVERSE POLARITY RF COAXIAL CONNECTORS

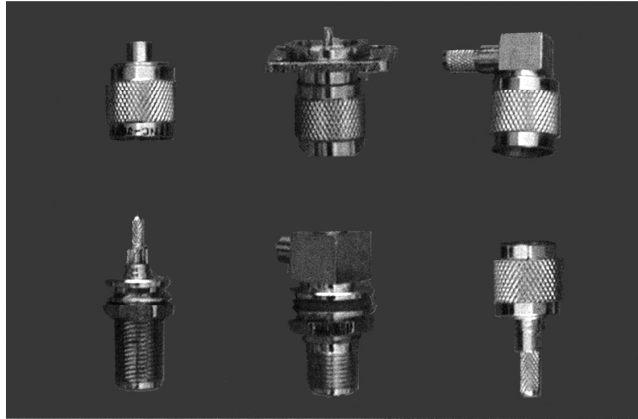

Adopt some occasions such as has strictly differentiated input and output entrance .and has special used entrance.

Key performance

- Characteristic Impedance : 50 Ω
- Frequency range : 0~11GHz
- Center resistance :
 - Center conductor ≤2.0m Ω
 - Out conductor ≤0.2m Ω
- Insulation resistance : ≥ 5000M Ω
- Insulator voltage withstanding : 1500V
- VSWR : ≤1.30
- Connector durability : 500 cycles

Executive standard : MIL-C-39012

Material

- Center contacts:
 - Male---brass, gold plated.
 - Female---phosphor bronze, gold plated
- Bodies and other metal parts:
 - brass, nickel plated
- Insulators: Teflon
- Crimp ferrule: copper, nickel plated.
- Gasket and seal rings: silicone rubber
- Heat-shrink tubing: thermofit plastic.

Interface Dimensions

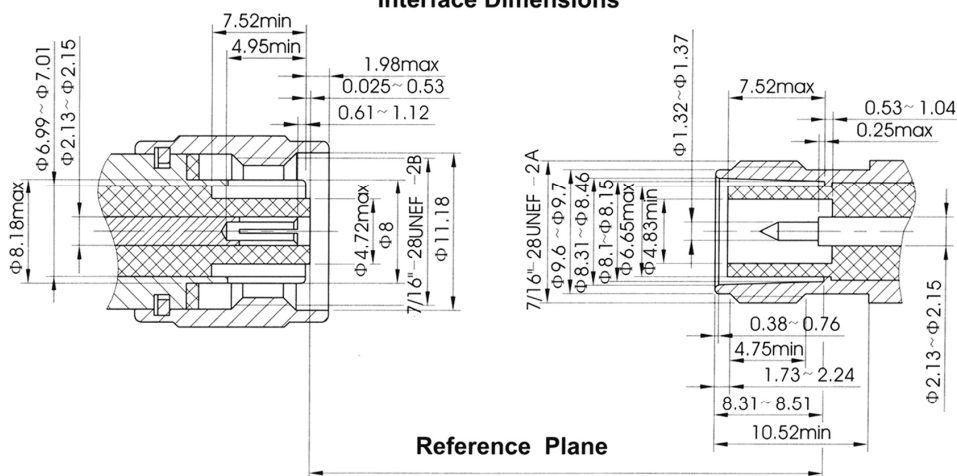

REVERSE POLARITY TNC

CERNEX, Inc.

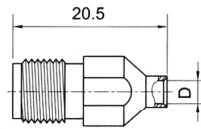

Type	part number	suitable cable	d	Note
TNC-FJB2	8211-6601	B2	Φ2.2	
TNC-FJB3	8211-6602	B3	Φ3.6	

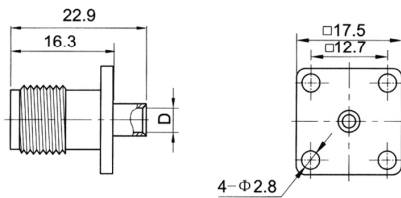

Type	part number	suitable cable	D	Note
TNC-FJFB2	8211-1601	B2	Φ2.2	
TNC-FJFB3	8211-1602	B3	Φ3.6	

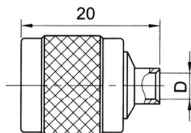
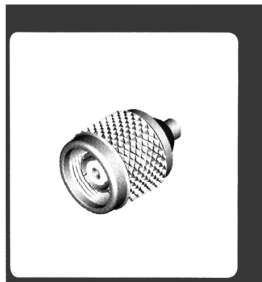

Type	part number	suitable cable	D	Note
TNC-FKB2	8221-6601	B2	Φ2.2	
TNC-FKB3	8221-6602	B3	Φ3.6	

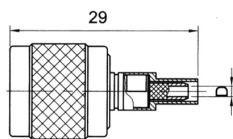
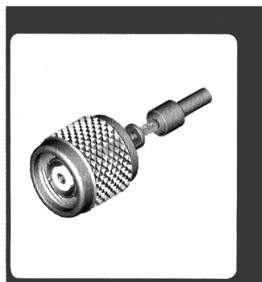

Type	part number	suitable cable	D	Note
TNC-FK3Y	8211-1501	3	Φ1.6	
TNC-FK5Y	8211-1502	5	Φ3.1	

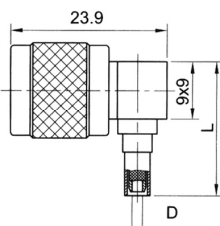
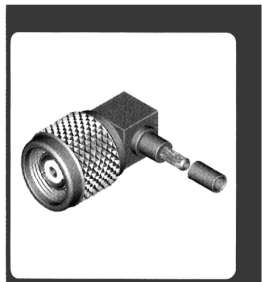

Type	part number	suitable cable	L	D	Note
TNC-FKW3Y	8241-6501	3	19.5	Φ1.6	
TNC-FKW5Y	8241-6501	5	26	Φ3.1	

REVERSE POLARITY TNC

CERNEX, Inc.

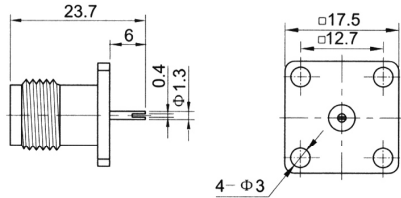
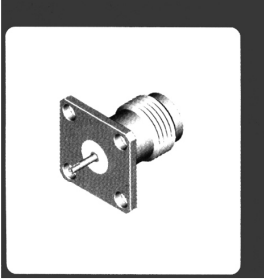

Type	part number	Note
------	-------------	------

TNC-FJFD	8211-0001	
----------	-----------	--

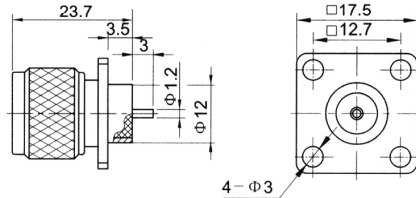
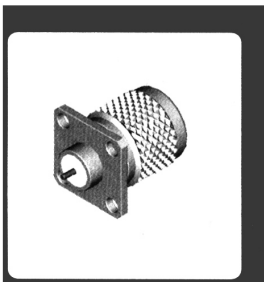

Type	part number	Note
------	-------------	------

TNC-FKFD	8221-0001	
----------	-----------	--

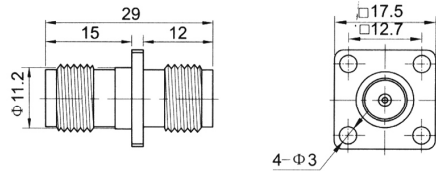
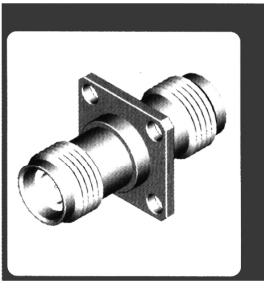

Type	part number	Note
------	-------------	------

TNC-FJFJ	8201-1901	
----------	-----------	--

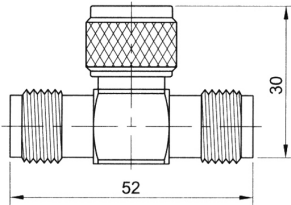

Type	part number	Note
------	-------------	------

TNC-FJKJ	8201-6902	
----------	-----------	--

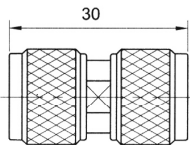

Type	part number	Note
------	-------------	------

TNC-FKK	8201-6901	
---------	-----------	--